

⊕ HOLDER TYPE H (Connect with base)

THANG LONG TECH[®]

Faster and Better

FEATURE OF PRODUCT (TÍNH NĂNG SẢN PHẨM)

- ✓ Smooth movement, compact design.
- ✓ High durability, low friction and noise.
- ✓ Made by SUS material, no copper.
- ✓ Available for customization
- ✓ Thiết kế nhỏ gọn, chuyển động mượt không để lại mặt.
- ✓ Độ bền cao, ít ma sát và tiếng ồn.
- ✓ Được làm hoàn toàn từ thép không gỉ.
- ✓ Làm theo nhu cầu của khách hàng.

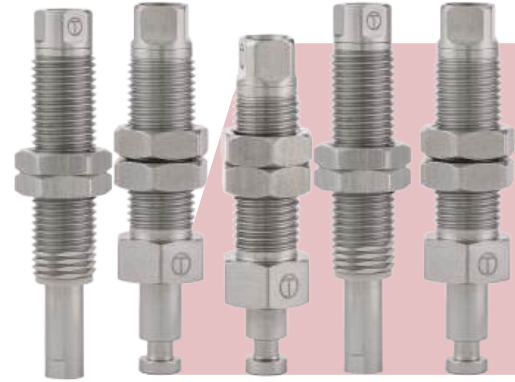

APPLICATION (ỨNG DỤNG)

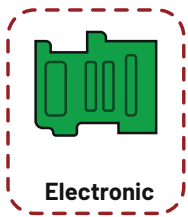

Electronic

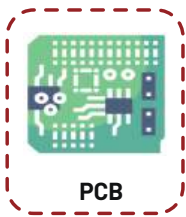

PCB

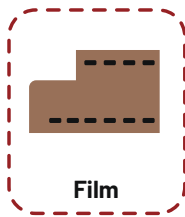

Film

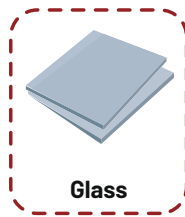

Glass

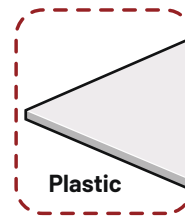

Plastic

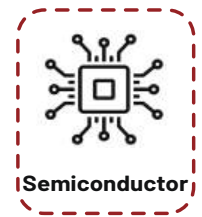

Semiconductor

PRODUCT DESCRIPTION (MÔ TẢ SẢN PHẨM)

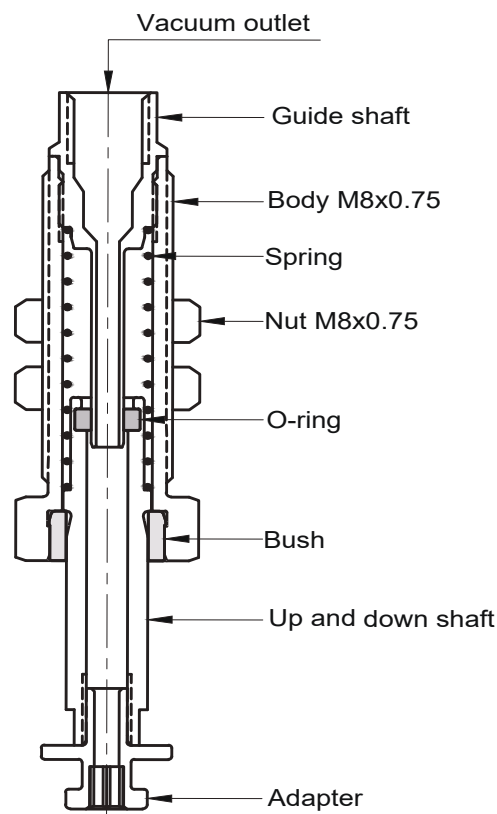

HOW TO ORDER (CÁCH ĐẶT MÃ)

Principle :

TYPE/SIZE - STROKE/ ROTATE/ ADAPTOR TYPE AND THREAD - CAP- FITTING - DN

	(1)		(2)		(3)	(4)	(5)
Example	H8	-	10RF3X5	-	C	- 14	- 1

(1) Type / kiểu:

H: Connect with base (Lắp với Base)

HJ: Connect with Jig (Lắp với Jig)

Size / Kích thước: 8, 10, 14...

(2) Stroke/ Rotate / adaptor (Hành trình, xoay, đầu kết nối)

Stroke (Hành trình) : 3,6,10, 15,20...

Rotatation (Xoay):

R= Rotate (Xoay) None = Non- Rotate (Chống xoay)

Adaptor thread (ren của đầu kết nối):

M: Male thread

F: Female thread

Adaptor size (kích thước đầu kết nối):

3 = M3 01 = 1/8

4 = M4 02 = 1/4

5 = M5 03 = 3/8

6 = M6 04 = 1/2

8 = M8

Adaptor style:

X: Cylinder type V: Anchor type

Y: Cone type T: Barb- Cylinder type

Z: Scew type P: Pillar (Insert) type

(3) Cap (Mũ)

C= Cap

Non = Non- cap

(4) Fitting (Đầu nối)

I: Straight type (đầu nối thẳng) L: L type (Đầu nối chữ góc)

Fitting size: $\varnothing 4, \varnothing 6, \varnothing 8, \varnothing 10, \varnothing 12...$

- Special dimension can be produced by custom specification.
- Kích thước đặc biệt có thể được sản xuất theo yêu cầu riêng của khách

THANG LONG TECH CO., LTD

Office: 25-26-27 TT3, Kim Quan Thuong Street, Viet Hung ward, Long Bien District, Ha Noi, Viet Nam

Tel: +84-24-3-6230117/0118/0119

Email: tlt@thanglongtech.com.vn

Website: www.thanglongtech.com.vn

⊕ HOLDER TYPE H (Connect with base)



Faster and Better

DIMENSION (KÍCH THƯỚC)

H8-3RF5-C-1 (Holder)	H8-6RF5-C-1 (Holder)	H8-10RF3-C-1 (Holder)
H8-3RF5X5-C-1 (Hoder with adapter)	H8-6RF5X5-C-1 (Hoder with adapter)	H8-10RF3X5-C-1 (Hoder with adapter)
H8-3RF5X5-C-I4-1 (Hoder with adapter and fitting)	H8-6RF5X5-C-I4-1 (Hoder with adapter and fitting)	H8-10RF3X5-C-I4-1 (Hoder with adapter and fitting)
H10-15RF5-C-1 (Holder)	ADAPTER	FITTING
H10-15RF5X5-C-1 (Holder with adapter)	<p>X5M5</p> <p>X6M5</p> <p>X6M5C</p> <p>Z6M5C</p> <p>X04M5</p> <p>Y5M5</p>	<p>Straight type</p> <p>L type</p>
H10-15RF5X5-C-I4-1 (Holder with adapter and fitting)		
		FITTING SIZE
		ø4, ø6, ø8, ø10, ø12...

THANG LONG TECH CO., LTD

Office: 25-26-27 TT3, Kim Quan Thuong Street, Viet Hung ward, Long Bien District, Ha Noi, Viet Nam

Tel: +84-24-3-6230117/0118/0119

Email: tlt@thanglongtech.com.vn

Website: www.thanglongtech.com.vn